

Automatic machine for espresso coffee and hot beverages

G 100 120V 60Hz

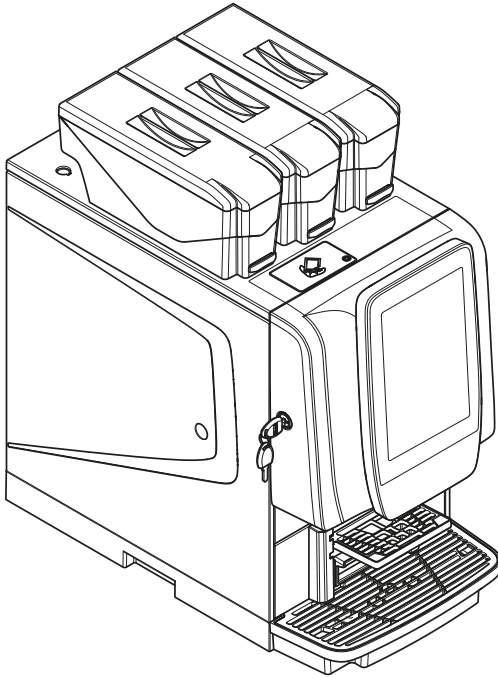

WARNINGS, CHARACTERISTICS, INSTALLATION



original Instructions / translation of the original instructions



DEFINITIONS

Manufacturer

It is a natural or legal person that manufactures radio equipment and/or electrical equipment, or has it designed or manufactured or markets it under its own trademark or name.

Importer

Any natural or legal person established in the European Union who places a product falling within the scope of the original regulations on the EU market from a third country.

Distributor

Any natural or legal person in the supply chain, other than the manufacturer or importer, who makes a product available on the market within the scope of the regulations.



Technical support staff

Qualified personnel performing operations with doors open where there is a risk of accessing live or moving parts. Technical support staff must be informed of the specific risks associated with their role. Technical support staff have an Access Key and an Override Key.

Maintenance personnel

Qualified personnel who fill containers and clean equipment. Maintenance personnel must have received appropriate training regarding the safety and hygiene requirements of the appliance. Maintenance personnel have an Access Key to enter the appliance for maintenance operations. Maintenance personnel are NOT in possession of the override key.

GENERAL WARNINGS

-  Before installing and using the appliance, the technical document contents need to be carefully read and understood, as the manual provides important information regarding installation safety, provisions of use and maintenance work.
-  An importer or distributor who places radio equipment or electrical apparatus on the market under its name or trademark becomes the manufacturer.

 An importer or distributor who makes changes to radio equipment or electrical equipment that has already been placed on the market and which affect its conformity with the listed Directives is considered a manufacturer. The manufacturer must therefore assume the relevant obligations under the Directives indicated.

 This document is an essential component of the appliance and must be included whenever it is moved or ownership is transferred so that it can be consulted at all times.

 The technical documentation is intended for technical personnel and is available in electronic format.
It can be downloaded from the website at the following URL:
<https://store.evocagroup.com/downloads>
or by contacting us using the form on the "Contact" page.

The documentation is in PDF (Portable Document Format) and can be viewed with any PDF reader or compatible web browser.

Technical documentation can be stored electronically and/or printed on a standard printer on A4 size paper, as required.

The purchaser has the right to request to obtain, free of charge, the instructions for use in paper format.



1. scan the QR code below to access the documentation page
2. enter the machine code in the "MACHINE CODE" search field.
The machine code is indicated on the label on the declaration of conformity
3. all available documentation for the machine code entered will be displayed





 This appliance may be used by children aged 8 years and above and persons with reduced physical, sensory or mental capabilities or lack of experience and knowledge if they have been given supervision or instruction concerning use of the appliance in a safe way and understand the hazards involved. Children should be supervised in order to make sure that they do not play with the appliance. Cleaning and maintenance to be carried out by the user must not be performed by children without supervision.





 This appliance is not intended for use by persons (including children) with reduced physical, sensory or mental capabilities, or lack of experience and knowledge, unless they have been given supervision or instruction concerning use of the appliance by a person responsible for their health and safety.

GENERAL SAFETY RULES

 Installation and subsequent maintenance and cleaning operations must be carried out by personnel specialised and trained in the use of the appliance, in accordance with current safety and hygiene regulations.







-  The appliance is intended for use in domestic and similar applications, such as personal kitchens, shops, offices and other work environments, farms and hotel guests and other residential environments, domestic and breakfast environments, catering and similar non-retail applications.



-  This appliance is intended to be used by expert or trained users in shop, in light industry and or farms, or for commercial use by lay persons.

-  The appliance is not suitable for outdoor installation.
-  The appliance must not be installed in environments where water jets are used for cleaning (e.g. large kitchens, etc.) and/or exposed to direct sunlight.
-  The appliance must be installed in dry rooms away from heat sources, at temperatures between 4°C (39.2°F) and 34°C (93.2°F).
-  If the appliance freezes, it must be conditioned at room temperature (20°C/68°F) for at least 6 hours.



-  The power cord must not be damaged or crushed by the appliance. If it is damaged, it must be replaced by the manufacturer or its authorised technical service centre or by qualified personnel.

-  The power cord must not be connected to a multiple socket outlet.

-  The appliance must be supplied with drinking water, taking into account the regulations in force in the country where the device is installed.
-  Only use new seals and connection pipes supplied with the appliance; do not reuse old ones.
-  The pressure values for appliances connected to the water mains must be within the values indicated on the appliance's data plate.
-  The sound pressure level is less than 70 dB.
-  **Access to the inside of the machine is only permitted to technical assistance personnel who have received appropriate training on the safety and hygiene requirements of the appliance.**
-  This appliance may be used by children aged 8 years and above and persons with reduced physical, sensory or mental capabilities or lack of experience and knowledge if they have been given supervision or instruction concerning use of the appliance in a safe way and understand the hazards involved. Children should be supervised in order to make sure that they do not play with the appliance. Cleaning and maintenance to be carried out by the user must not be performed by children without supervision.

-  This appliance is not intended for use by persons (including children) with reduced physical, sensory or mental capabilities, or lack of experience and knowledge, unless they have been given supervision or instruction concerning use of the appliance by a person responsible for their health and safety.
-  Beverage dispensers in open containers are to be used exclusively for the sale and distribution of beverages declared by the manufacturer as "suitable for automatic distribution" in open containers.
-  Always refer to the expiry date, storage specifications and storage temperature of the product. All products should be consumed immediately. Under no circumstances should they be stored and/or packaged for later consumption.

WARNINGS FOR INSTALLATION

-  Before installing and using the appliance, please read and understand the contents of this manual carefully, as it contains important information regarding installation safety.
-  **Installation and subsequent technical assistance and maintenance operations must be carried out with the appliance connected to the power supply and therefore by specialised personnel trained in the use of the appliance and informed of the specific risks involved.**

-  **Installation and subsequent test operations must be performed by qualified personnel, with specific knowledge of the appliance's operation both from an electrical safety and hygiene point of view.**

-  **The appliance must only be installed in environments where it can be supervised by qualified maintenance personnel.**







-  The appliance must be placed on a flat, horizontal surface.



-  The appliance can be placed near a wall, but there must be a minimum distance of 4 cm from the wall to allow for ventilation.

-  In the event of unscheduled technical assistance, maintenance and/or repair work, the appliance must be accessible from all sides. It must therefore be possible to rotate the appliance so that the rear and side panels can be removed.

-  The appliance is equipped with automatic washing functions. If the use of the appliance is subject to pauses (e.g. weekends, etc.) of even more than two days, it is a good idea to enable the automatic washing functions, e.g. before the commencement of use.

-  Once the appliance has been installed, the hydraulic circuits and parts that come into contact with food must be sanitised to eliminate any bacteria that may have formed during storage.

-  The use of kits and/or accessories not approved by the manufacturer does not guarantee compliance with safety standards, particularly for live parts.
-  The party that performed the installation is solely and exclusively responsible for any damage that may occur to the appliance, or to things and people due to incorrect installation.
-  Some illustrations in this manual may show details that differ from the appliance, without however altering the essential information.
-  The manufacturer is not liable if non-approved components are used.
-  Under no circumstances should the machine be covered with cloths or similar items.
-  After removing the packaging, check that the appliance is intact. If in doubt, do not use it.

-  The packaging materials (plastic bags, expanded polystyrene, nails, etc.) must be kept out of the reach of children as they are a potential source of danger.
-  Packaging materials must be disposed of in an environmentally friendly manner at authorised disposal sites, entrusting the recovery of recyclable materials to specialised companies.
-  The integrity of the appliance and its compliance with the relevant regulations must be checked at least once a year by technical support staff.

HYGIENE AND CLEANING INSTRUCTIONS









-  The manual indicates potential weak points and provides instructions for controlling possible bacterial proliferation.

-  Beverage dispensers are to be used exclusively for the sale and distribution of food beverages obtained by: brewing products such as coffee and/or tea; The reconstitution of instant or freeze-dried products. pasteurised or UHT milk. These products must be declared by the manufacturer as "suitable for automatically dispensing" into open containers. The products dispensed are to be consumed immediately upon dispensing: Under no circumstances should they be stored and/or packaged for later consumption.





-  Wash hands and wear disposable gloves before cleaning and loading; the use of gloves does not replace the need for hand hygiene.

-  In accordance with current health and safety regulations, the operator of the appliance must apply self-monitoring procedures, identified in accordance with the provisions of the HACCP (Hazard Analysis Critical Control Point) directive and national legislation.

-  Always switch off the appliance before starting any maintenance work which requires disassembling components.

-  Each time the product is refilled, or more frequently depending on the use of the appliance, the quality of the incoming water and the products used, the appliance must be thoroughly sanitised to ensure the hygienic quality of the products dispensed.
-  Sanitisation is carried out using disinfectant products, taking care to mechanically remove any visible residues and films using the appropriate accessories (brushes and/or scrubbing brushes, if available), following the instructions in the cleaning section of the manual.
-  The milk circuit must be cleaned every 24 hours following the washing procedure guided by the machine with the detergents recommended and/or supplied by the manufacturer.
-  The use of cleaning products suitable for contact with food is permitted; for dosage and application times refer to the instructions on the product.
-  It is good practice to also sanitise surfaces that do not come into direct contact with food inside the appliance, as well as the side modules (cup warmers, coolers, etc.).
-  Do not use solvents and/or strong-scented detergents.
-  Some parts of the appliance can be damaged by aggressive detergents. The manufacturer shall not be held responsible for any damage caused due to the non-observance of the above or the use of aggressive or toxic chemical products.
-  Do not under any circumstances use water jets to clean the appliance.

WARNINGS FOR THE ENVIRONMENT

-  A few measures will help to respect the environment:
-  Only use biodegradable products to clean the appliance;
-  Dispose of all packaging used to load and clean the appliance in an appropriate manner;
-  Switching off the equipment during periods of inactivity will result in significant energy savings.

WARNINGS FOR DISMANTLING AND DISPOSAL

When dismantling the machine, it is recommended that its rating plate be destroyed.



The symbol indicates that the appliance cannot be disposed of as normal waste, but in accordance with legislation in force and the resulting national legislation to prevent possible negative consequences for the environment and human health.

Separate collection of end-of-life equipment is organised and managed by the manufacturer.

Appropriate separate collection of the component parts of the appliance encourages the reuse and/or recycling of the materials of which the appliance is composed. For the correct disposal of the appliance, contact the point of sale where the appliance was purchased or our after-sales service.

Illegal disposal of the appliance by the holder entails negative effects on the environment and health, as well as the application of administrative sanctions as provided for by regulations in force.

PRIVACY WARNINGS





Only for devices that have a video camera and/or webcam.

The video camera and/or webcam is disabled by factory settings; if it is enabled, it takes images without sound and without the possibility of storage.

The Customer acknowledges that, in the event of activation of the video camera and/or webcam incorporated in the equipment, he/she will become the owner of the personal data acquired.

From that moment onwards, the Data Controller assumes all the relevant rights and obligations under the relevant provisions in force.

SPARE PARTS WARNINGS

-  The use of original spare parts available on the manufacturer's e-commerce site is recommended.
-  Using only original spare parts guarantees maximum reliability and product quality. Original parts have been specifically designed and tested to work with the appliance, minimising the risk of failures, malfunctions and compatibility.
-  Non-original spare parts may not be compatible with the apparatus, causing malfunctions or necessitating further modifications.
-  Original spare parts are designed to meet the safety standards set by the manufacturer. The use of non-original parts and/or parts not authorised by the manufacturer compromises the safety of the appliance, causes damage to persons, property and animals, and harms the health of the end consumer.
-  The manufacturer accepts no liability for the use of non-original and/or non-manufacturer-approved components.

INTEGRATION OF RADIO MODULES

In accordance with Article 17 of Directive 2014/53/EU (RED), the manufacturer shall carry out the conformity assessment of the radio equipment with the essential requirements of Article 3 of the Directive.

The conformity assessment procedure used is at the choice of the manufacturer.

Where a radio module is integrated into "non-radio" equipment, the party integrating the module becomes the manufacturer of the final product and is therefore obliged to carry out the conformity assessment of the final product with the essential requirements of Directive 2014/53/EU (RED).

In fact, the integration of radio modules into other products can influence the conformity of the final product with the essential requirements of the Directive.

SYMBOLOLOGY

DANGER



Electrical hazard
Located near points where there is a risk of electrical contact.
Disconnect the power supply before accessing these points.



General hazard
The symbol is accompanied by additional hazard text



Hot surface hazard
It is located near points where the surface temperature exceeds 60°C (140°F).



Danger of steam emission.
Only for appliances with steam boiler



Flammable material hazard
Only for appliances with refrigerant gas

OBLIGATION



It is mandatory to read the instructions



It is mandatory to ensure that the device is earthed



It is mandatory to disconnect the equipment from the power supply

Prohibition



Never spray with water

I PREAMBLE

I.1 TRANSPORT AND STORAGE

TRANSPORT

Special care must be taken when handling the appliance in order to avoid causing damage to the appliance and people.

During handling, there is a risk of crushing hands and/or feet: suitable Personal Protective Equipment (PPE) such as gloves and work shoes should therefore be worn at all times.

Move the appliance using lifting equipment that is suitable for the size and weight of the appliance (e.g. a forklift).

Only qualified personnel is allowed to use the lifting equipment.

Do not:

- tipping over and/or tilting the appliance;
- dragging or lifting the appliance with ropes or similar;
- lifting the appliance with lateral grips;
- shaking or tossing the appliance and its packaging.

Storage

The storage environment must be dry and at temperatures between 32 and 104 °F.

If the appliance freezes, it must be conditioned at room temperature (68 °F) for at least 6 hours.

I.2 IN THE EVENT OF MALFUNCTION

In the event of a failure or malfunction that can not be solved, please contact:

Evoca S. p. A.
Via Roma 24
24030 Valbrembo
Italy - Tel. +39 035606111

I.3 APPLIANCE IDENTIFICATION AND FEATURES

Each piece of equipment is identified by a specific serial number, which can be found on the data plate.

The plate is located inside the appliance and displays its details.

The data plate is the only one recognised by the manufacturer and contains all the information that enables the manufacturer to provide technical information of any kind quickly and safely and to facilitate spare parts management.

 **DO NOT** remove, **DO NOT** tamper with and **DO NOT** modify the data present

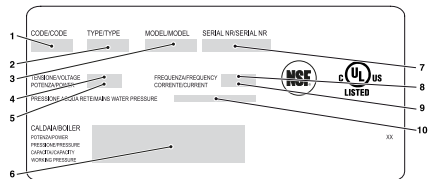

1. Product code
2. TYPE
3. Model
4. Operating voltage
5. Power consumption
6. Heating unit details
7. Serial number
8. Operating voltage frequency
9. Current
10. Water mains properties

I.4 TECHNICAL FEATURES

Dimensions

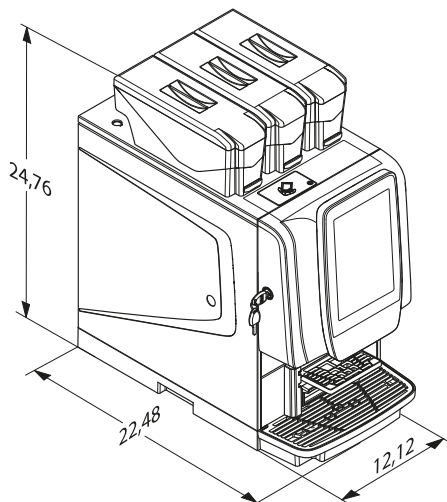

POWER SUPPLY

For voltage, frequency and maximum power values please refer to the rating plate inside the equipment.

NOISE LEVEL

The level of continuous, equivalent, weighted acoustic pressure is less than 70 dB.

WATER SUPPLY

Water supply with water pressure between 7.3 and 145.04 psig (0.5 and 10 bar).

The appliance software is designed to manage the water supply from an internal tank (optional kit).

PERMISSIONS

- Water present
- Coffee present
- Presence of solid residue trays
- Presence of product containers
- Brewing unit position
- Liquid residue empty
- Operating temperature reached
- Door closed

SAFETY MEASURES

- Product container presence sensor
- Residue tray presence sensor
- Door sensor
- Connectivity switch
- Safety thermostats for heating unit(s) with manual reset
- Safety valve steam heating unit (only models with a cappuccino maker)
- Power button (manual type)
- Air break float jam
- Liquid residues full
- Short circuit/heating unit probe interruption check

COUNTDOWN PROTECTION DEVICE OF THE:

- Pump
- brewing unit gear motor
- grinder(s)

THERMAL PROTECTION DEVICE OF THE:

- Motor-dosers
- brewing unit gear motor
- Coffee release electromagnet (only versions with volumetric dosing device)
- Pump
- Milk pump (only models with a cappuccino maker)
- Mixer motors
- Grinder motor

I.5 ACCESSORIES AND KIT

The appliance can be fitted with accessories and kits in order to vary its performances. The accessories and kits that can be attached to the appliance are available from the manufacturer.

The accessories and kits are supplied with installation and test instructions, which should be scrupulously followed in order to keep the appliance operating safely.

The party that performed the installation is responsible for any damage that may occur to the appliance, or to things and people due to incorrect installation.

Important!!!

Accessories and kits that have not been approved by the manufacturer, may not comply with the safety standards, most especially in regards to live parts.

The manufacturer is not liable if non-approved components are used.

Installation and subsequent test operations must be performed by qualified personnel, with specific knowledge of the appliance's operation both from an electrical safety and hygiene point of view.

1.6 INTENDED USE

Vending machines in open containers (glasses, cups, carafes, etc.) are to be used exclusively for the sale and distribution of food beverages obtained for:

- Brewing of coffee or tea;
- The reconstitution of instant or freeze-dried products.

All products used must be declared by the manufacturer as "suitable for vending" in open containers.

Products must be kept in strict accordance with the manufacturer's instructions regarding storage, storage temperature and expiry date.

The dispensed drinks should be consumed immediately and must, under no circumstances be stored and/or packaged for later consumption.

Any other use is considered improper and therefore potentially dangerous.

1.7 SWITCHES AND SAFETY DEVICES

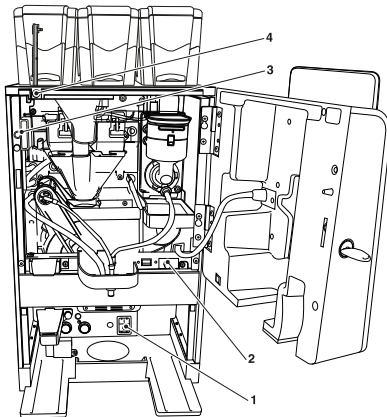

1. Power button
2. Door sensor
3. Sustained action button
4. Connectivity switch

The switches are always in the same position regardless of the appliance model or internal layout. The illustration is intended solely to represent their position and is valid for all versions of the appliance.

Power button

The main switch (manual type) disconnects the power supply to the appliance and is located at the bottom right. When carrying out normal cleaning and product loading tasks, the appliance does not have to be switched off.

Inside the appliance, only the parts that are protected by covers and marked with the symbol below remain live.



Before removing these covers, the power supply cable must be disconnected from the mains.



Door sensor

The open and/or closed status of the door is indicated by a magnetic sensor.

Sustained action button

If present

The sustained action button prevents material damages and injuries in the event of unexpected or uncontrolled movements of the machine.

The sustained action button is active only when used in combination with the yellow key.

In order to enable the movement of the functional units when the door is open (e.g. to reposition the brewing unit), the magnetic key must be placed on the door closing/opening sensor and this button held down.

 All operations which require the appliance to be live with the door open, must be performed **EXCLUSIVELY** by qualified personnel who are aware of the specific risks that the machine entails in this condition.

Connectivity switch

When the door is opened, a specific switch deactivates the appliance's connectivity components.

When the door is open, the operation of the functional units and/or the remote control are disabled.

 All operations that require the appliance to be live with the door open and the connectivity functions active, must be performed **EXCLUSIVELY** by qualified personnel who are aware of the specific risks involved when the machine is in this condition.

SAFETY MEASURES

Routine cleaning and product loading operations can be carried out in complete safety.

The unit has magnetic sensors that detect:

- The closing of the door
- The presence of the containers
- The presence of the residue trays

In the absence of one of the listed conditions, the appliance is disabled.

This appliance is equipped with a magnet that allows the appliance to operate with the door open.

 The magnet must absolutely not be left inside the appliance but must be kept by specialised personnel trained in the use of the equipment.

2 INSTALLATION

The installation and subsequent maintenance operations must be carried out with the appliance connected to the power supply and therefore by specialised staff, who are trained to use the appliance and have been informed of the specific risks deriving from such a situation.

The appliance must be installed in dry rooms with temperatures between 39.2°F and 93.2°F and must not be installed in environments where water jets are used for cleaning (e.g. large kitchens, etc.).

 During the appliance installation operations, use law-compliant gloves and work shoes, classified as personal protective equipment (PPE).

 The PPE must be adequate to protect the wearer from mechanical risks (cuts, scrapes and crushing, etc.) and physical risks (hot water, etc.).

 The appliance must be installed in environments where it can be overseen by trained staff.

 When the appliance has been installed, the hydraulic circuits and the parts that come into contact with the food products need to be sterilised in order to eliminate any bacteria which could have formed while the machine was in storage.

2.1 UNPACKING THE APPLIANCE

After the packaging has been removed, check the condition of the appliance.

If any doubts should arise, do not use the appliance.

The packaging materials (plastic bags, expanded polystyrene, nails, etc.) must be kept out of the reach of children as they are a potential source of danger.

The packaging materials need to be disposed of in authorised waste disposal centres. Recyclable materials should be given to specialised recycling companies.

2.2 POSITIONING

 The appliance is not suitable for outdoor installation. It must be installed in dry rooms with temperatures between 39.2°F and 93.2°F and cannot be installed in environments where water jets are used for cleaning (e.g. large kitchens, etc.).

 The equipment must be installed in areas where it can be kept under the supervision of trained personnel.

The appliance can be positioned close to a wall but there must be a gap of at least 4 cm between the wall and the appliance for ventilation purposes.

Under no circumstances should the machine be covered with cloths or similar.

 The appliance must be positioned on a level surface so that the maximum inclination does not exceed 2°.

 Access for extraordinary maintenance and/or repairs is possible from all four sides. It must therefore be possible to rotate the appliance on its own axis in order to remove the backrest and side panels.

2.3 WATER SUPPLY

The appliance must use potable water and take into account the regulations in force where the appliance is installed.

The appliance must be installed with adequate backflow protection to comply with federal laws and local codes.

The appliance must be connected to the drinking water supply with a pressure between 7.3 and 145.04 psig (0.5-10 bar).

Run the water from the mains until it is clear and dirt free.

Connect a suitable tube (also available as a kit) that can withstand the mains pressure and is suitable for food use (minimum internal diameter of 0.2362 inches) to the 3/4"G connection of the water inlet solenoid valve.

We recommend installing a tap on the water mains outside the appliance, in an accessible position.

 To connect the machine to the water mains, only use new seal and hose sets that comply with current standards.

 Do not reuse any existing materials.

WITH TANK

Only for versions with tank.

Use the self-feeding tank specifically designed for the appliance.

Descaler device

The appliance is not supplied with a water softener. In the event that the appliance is connected to a water mains with very hard water, a water softener must be installed. Use water softeners that have a big enough capacity to be effectively used in the appliance.

If the appliance uses a water tank, appropriate filter cartridges can be used. The cartridges will need to be replaced periodically depending on the water quality and the instructions given by the manufacturer.

The descalers are also available as accessories; they must be periodically regenerated or replaced according to the manufacturer's instructions.

2.4 ELECTRICAL CONNECTION

The appliance is designed for electric operation with a single-phase voltage of 120 V - 60 Hz.

When connecting, ensure that the rating plate data correspond to the grid data, in particular: that the value of the supply voltage is within the recommended limits for the connection points;

 It is imperative to employ a primary switch that adheres to the prevailing installation standards and ensure that it is situated in a readily accessible area. The switch must possess the appropriate attributes to endure the highest demanded load and guarantee a complete disconnection from the power source in situations involving overvoltage category III. This is necessary to safeguard the circuit against ground faults, overloads and short circuits..

The switch, socket and plug must all be placed in an accessible position.

The appliance is to be considered electrically safe only when it has been correctly connected to an efficient earthing system, in accordance with the current safety regulations.



It is important to have this fundamental requirement checked. If in doubt, have the system carefully checked by a qualified professional.

The replacement cable is available from the manufacturer or its service agent. The cable must be replaced by the manufacturer, an authorised service centre or qualified personnel.

⚠ The use of adapters, multiple plugs and/or extension leads is forbidden.

The manufacturer waives all responsibility for any damage caused due to the failure to follow the aforementioned precautions.

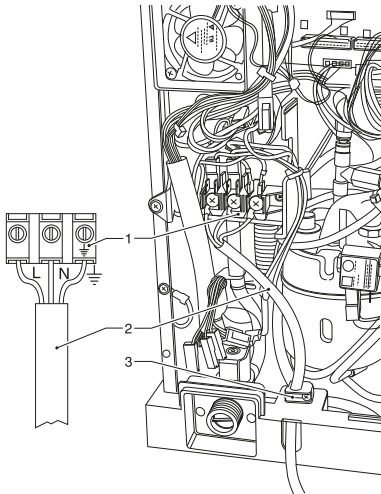

1. Connection terminal board
2. Electric cable
3. Cable clamp

⚠ The electrical cable must not be damaged and/or crushed by the equipment.

⚠ The electric cable must not be in the proximity of liquids and/or submerged.

⚠ The electric cable must not be near heat sources.

2.5 INITIAL START-UP

The first time the appliance is switched on, a wizard sequence for preliminary settings (language, appliance name, etc.) is displayed.

After the selections have been made, the hydraulic circuit is filled up (installation).

The installation procedure varies depending on whether the appliance obtains its water supply from a tank or the water mains.

MAINS WATER SUPPLY

- Upon start-up, the mains solenoid valve is automatically opened until the air-break is full.
- A heating unit solenoid valve opens to vent the air in the circuit.

ⓘ If there is a lack of water during the installation cycle, the appliance will stop and wait for the water.

ⓘ If substantial water pockets form in the hydraulic circuit, then the hydraulic circuit must be manually filled.

After filling the hydraulic circuit, the brewing unit moves to the operating position.

The display shows in sequence:

- the software version of the appliance;
- the heating cycle status.

When the heating cycle has finished, the beverages will be available.

WATER SUPPLY FROM A TANK

- When the appliance is switched on, the auto-feed pump is activated for 10 seconds. The display shows "no water".
- Use the "heating unit filling/emptying" function in the "System" menu.
- After filling the hydraulic circuit, reset the "no water" fault.

2.6 FIRST SANITISATION

When the appliance has been installed, the hydraulic circuits and the parts that come into contact with the food products need to be sterilised in order to eliminate any bacteria which could have formed while the machine was in storage.

Before proceeding with cleaning, wash hands and wear disposable gloves: the use of gloves does not replace the need for hand hygiene.

The components to be cleaned are:

- The mixer;
- Dispensing nozzles
- Liquid residue tray
- Tank (if present);
- Product containers.
- BREWING UNIT
- Milk circuit (only models with a cappuccino maker)

 Under no circumstances should jets of water be used for cleaning.



The sanitisation is performed using sanitising products.

 The appliance has automatic cleaning functions for the main components.

If the use of the appliance is subject to breaks in use (weekends, etc.) of even less than two days, it is practical to enable the automatic washing functions (e.g. before the start of use of the appliance).

2.7 PERIODICAL OPERATIONS AND CLEANING

Before proceeding with cleaning, wash hands and wear disposable gloves: the use of gloves does not replace the need for hand hygiene.

Under current health and safety regulations, the operator of the appliance must apply the self-control procedures, identified in accordance with the HACCP (Hazard Analysis Critical Control Point) Directive.

The use of cleaning products suitable for food contact is permitted; for dosage and application times refer to the instructions on the product.

It is also good practice to use sanitising products when cleaning the surfaces that do not come into direct contact with the food products.

The manufacturer shall not be held responsible for any damage caused due to the non-observance of the above or the use of aggressive or toxic chemical products.

Disconnect the appliance from the mains power supply before carrying out any maintenance operations that require the removal of components.



Do not under any circumstances use jets of water directly on the appliance when cleaning.



 Guided cleaning must be performed at the end of each service, or more frequently, depending on the use of the appliance.

 Washing cycles do not replace the need to dismantle components regularly for cleaning.

Every time the appliance is loaded and/or weekly or more frequently depending on the use of the appliance, the quality of the water and the products used, it is necessary to sanitise:

- The mixer.
- Dispensing nozzles.
- Liquid residue bucket.
- Water tank (if present).
- Brewing unit.

The sanitisation must be performed using disinfectants, whilst taking care to mechanically remove the residues and visible films using swabs and/or brushes.

The maximum level on containers is generally indicated by a mark or reference line; in other cases, it coincides just below the point of contact of the lid with the actual point of contact of the lid.

2.8 Product loading

 Before loading the products, check that they have been stored in compliance with the manufacturer instructions regarding storage and the storage temperature.

 Before loading the products, check the expiration date.

The products must be declared by the manufacturer as "suitable for automatically dispensing" into open containers.

Products may also be loaded with partially-full containers.

Make sure not to exceed the maximum level of the containers.

Do not exceed the maximum capacity of the containers.

The manufacturer reserves the right to change, without notice, the characteristics of the equipment presented in this publication; it also disclaims all liability for any inaccuracies due to printing and/or transcription errors contained therein.

If any subsequent improvements or adjustments are made to the appliance, the manufacturer is under no obligation to modify previously supplied appliances, or to update the relative technical documentation supplied with them.

All the instructions, drawings, tables and information contained in this publication are confidential and can neither be fully or partially reproduced, nor transmitted to third parties without the written permission of the manufacturer, who is the exclusive owner.

