



CLEANING GUIDE

for Key Holder

Cafection **Encore Venti**



Need Assistance?

Contact your service provider.

TABLE OF CONTENT

Important Notices	5
Daily Routine	6
Filling Up Ingredients	7
Performing a Rinse	8
Emptying the Waste Bin	9
Changing the Filter Paper (if Empty)	10
Cleaning the Unit.....	11
Weekly Routine	12
Cleaning the Coffee Chute or Internal Waste Bin	13
Cleaning the Soluble Canisters Elbows	14

Important Notices

This guide is designed to help you maintain your machine clean and in good condition by suggesting simple and easy steps.



Do not perform advanced maintenance if you did not receive an adequate technical training.

Parts are **not** dishwasher safe.

All parts in contact with food must be air dried **completely** before reinstalling.*

RECOMMENDED TOOLS AND CLEANING MATERIAL:

- Small brush, suitable for food-contact surfaces and hot water
- Brush for coffee grounds, suitable for food-contact surfaces
- Scissors
- Water resistant and lint-free towel
- 100% cotton soft cloths
- Mild non-abrasive cleaner
- 16-ounce container (preferably reusable)

**Air drying is the only drying method approved by Cafectio to prevent contamination. In the event you use a towel, make sure to follow the manufacturer cleaning instruction.*

Daily Routine

BEGINNING OF THE DAY

- Fill up the ingredient canisters and condiments dispenser

DURING THE DAY, WHEN REQUIRED

- Perform a rinse
- Empty the waste bin
- Verify the filter paper level and change the roll if empty

END OF THE DAY

- Clean the unit
- Empty and clean the drip tray and grill
- Tidy up the coffee area

Filling Up Ingredients

- 1 Unlock and remove the hopper top lid, then fill up the bean hoppers.

Make sure to avoid cross-contamination.

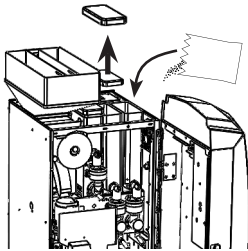
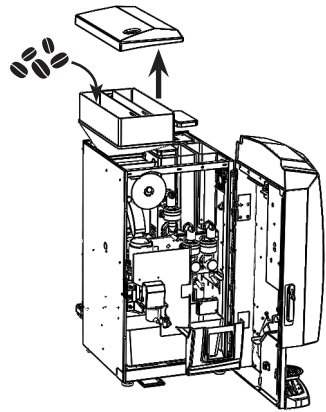

- 2 Open the door and remove the plastic hood. Remove lids of the soluble ingredients canisters **one at a time** and fill them up.



- 3 Access Service mode:

1. Open the door.
2. Press on the SW1 button (white) on the main board.

- 4 Access the Product Levels screen and adjust the levels using the bean icon.

Exit Service mode. Reinstall the hood and close the door.

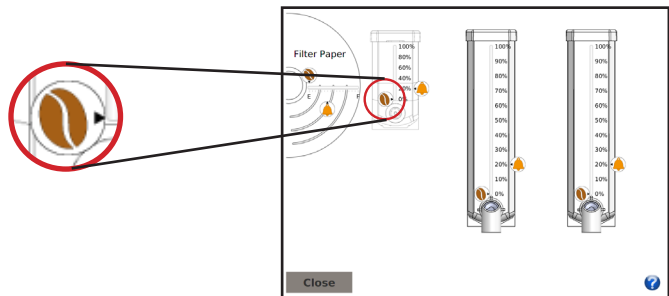

- 5 Make sure your cup and condiment dispenser is full with stirrers, sugars, cups, etc.

Performing a Rinse

- 1 Place an empty container under the spout. Make sure it has a minimum capacity of 16 oz.

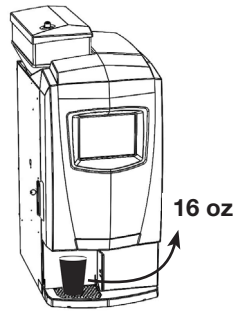

- 2 Access Service mode:

1. Open the door.
2. Press on the SW1 button (white) on the main board, then close the door.

- 3 Perform an auto rinse.

Verify if your container is well positioned and tap the “Rinse” button on the popup window.

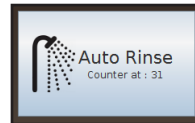

Wait until water has completely finished dripping. Be careful, the water is **VERY HOT**.



Once the rinse is completed, exit Service mode.

- 4 Empty the container. Be careful, the water is **VERY HOT**.

Do not drink this water.



Emptying the Waste Bin

- 1 Open the brewer door and remove the brew group protective panel.

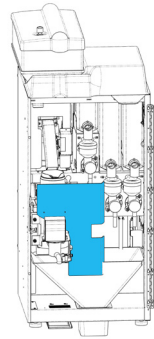
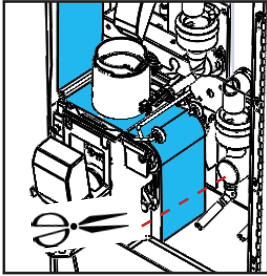

- 2 Cut the filter paper 4 inches below the brew group with scissors.

DO NOT YANK ON THE PAPER!

- 3 **MACHINE WITH COFFEE CHUTE**

Change the bag of the waste bin under the counter. Reinstall the protective panel and close the brewer door.

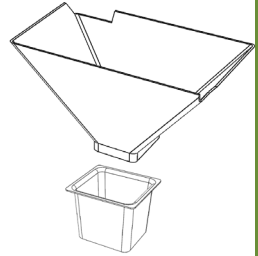

MACHINE WITH INTERNAL WASTE BIN

Remove the internal waste bin from the unit and empty it. Put the waste bin back in the unit.

DO NOT USE A PLASTIC BAG.

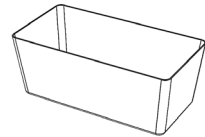

Reinstall the protective panel and close the brewer door.

- 4 Access Service mode:

1. Open the door.
2. Press on the SW1 button (white) on the main board.

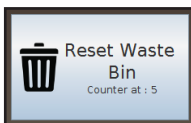

Reset the waste bin counter, then exit Service mode.

Changing the Filter Paper (if Empty)

1 Access Service mode:

1. Open the door.
2. Press on the SW1 button (white) on the main board, then close the door.

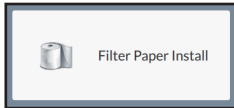

Tap "Filter Paper Install".

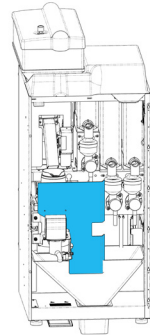

2 Open the brewer door, remove the protection panel and remove the empty filter paper roll.

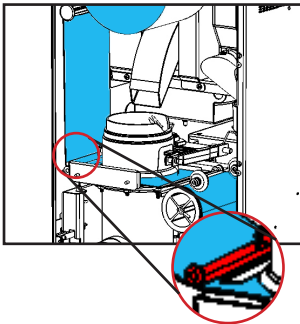

3 Install the new roll. Feed the paper under the left guide bracket of the brew group, under the brew chamber and under the wheel guides by gently lifting them using the yoke. Then close the door.

4 Tap "OK" on the installation popup window.

Choose "Yes" to the question "Did you replace the filter paper roll with a new full roll?"

Exit Service mode.

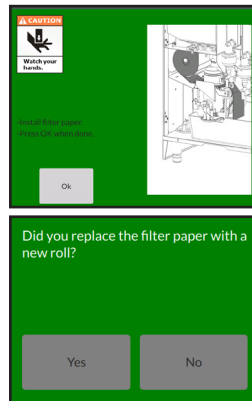

Cleaning the Unit

1 CLEANING

To minimize scratching and preserve a neat appearance, Cafection recommends using a **soft cloth** to clean the surfaces.

Use a non-abrasive cleaner to clean the exterior of the unit and the base cabinet.

Always spray the cleaner on the cloth, never directly on the machine components.

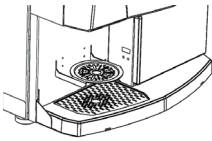

Empty the drip tray, then rinse the tray and its grill under hot water. If needed, use a soft soap.

WARNING! Drip tray may be full of hot liquid.

Brush the inside of the unit to remove any bean, soluble powder or other residues.

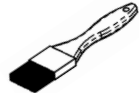

Do not use soap or cleaner to clean the inside of the brewer. Use only hot water if necessary.

Non food-contact parts you need to verify and clean:

- Touch screen
- Plastic top lid
- Cabinet (optional) or counter
- Metal surfaces (outside)
- Plastic door (inside and outside)
- Front panel (inside)
- Drip tray
- Inside of the unit

2 DRYING

After removing all food residues, thoroughly **dry each parts with a clean, soft cloth.**

3 TIDYING UP THE AREA

Make sure the cups are safely displayed and the condiments are stored in the cup & condiment dispenser (optional).

Leave the coffee area clean and organized.

Weekly Routine

AT THE END OF THE WEEK

- Clean the coffee chute or internal waste bin
- Clean the soluble canisters elbows

VISUAL INSPECTION

- Soluble ingredients whipper assembly
- Soluble ingredients canisters
- Bean hopper

Cleaning the Coffee Chute or Internal Waste Bin

- 1** Open the brewer door, remove the brew group protective panel and cut the filter paper (refer to **step 1 and 2** of the “*Emptying the Waste Bin*” section on **page 9**).

2 MACHINE WITH COFFEE CHUTE

Remove and clean the chute inside the brewer.

Put the chute back in the unit, reinstall the protective panel and close the brewer door.

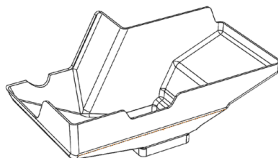

MACHINE WITH INTERNAL WASTE BIN

Remove the internal waste bin from the unit, empty and clean it.

DO NOT USE A PLASTIC BAG.

Put the waste bin back in the unit, reinstall the protective panel and close the brewer door.

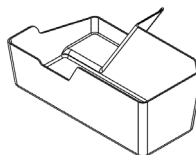

- 3** Access Service mode and reset the waste bin counter (refer to **step 4** of the “*Emptying the Waste Bin*” on **page 9**).

Cleaning the Elbows of the Soluble Ingredients Canisters

- 1** Open the brewer door. Carefully pull the elbows out of the soluble ingredients canisters.
- 2** Clean the elbows under hot water until all food residues have been removed.
- 3** Air dry completely, then reinstall the elbows on their proper soluble ingredients canisters.

Close the door.

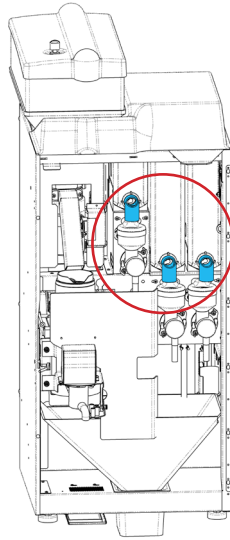

WEEKLY VISUAL INSPECTION

- Soluble ingredients whipper assembly

Each soluble ingredients whipper should not be clogged nor blocked.

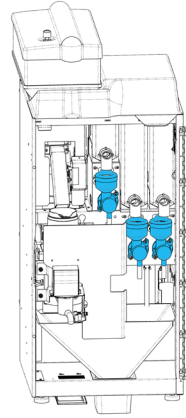

- Soluble ingredients canisters

The soluble ingredients canisters should be clean and the nozzles free from clogging.

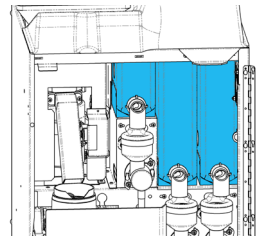

- Bean hopper

The bean hopper should be clean and free from coffee oil.

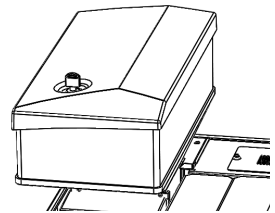

If you notice any issue with one or more of these parts, contact your service provider to get technical assistance.



cafetionevoca.com

